

Product Image

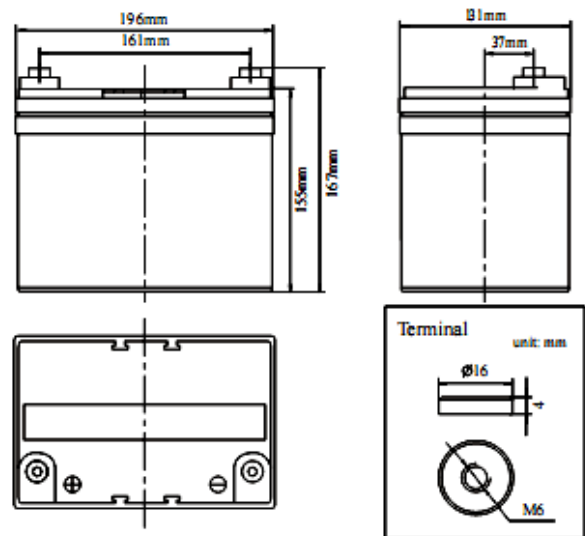

Product Dimensions



Characteristics

Nominal Voltage		12V
Nominal Capacity (20 hour rate)		35Ah
Capacity 25°C (77 °F)	10 hour rate (3.2A)	32Ah
	5 hour rate (5.6A)	28Ah
	1 hour rate (19.4A)	19.4Ah
Internal Resistance	Full Charged Battery 25°C	≤12mΩ
Capacity affected by Temperature (10 hour)	40°C (104 °F)	102%
	25°C (77 °F)	100%
	0°C (32 °F)	85%
	-15°C (5 °F)	65%
Self-Discharge 25°C (77 °F) Capacity	after 3 month storage	90%
	after 6 month storage	80%
	after 12 month storage	62%
Charge (Constant Voltage) 25°C (77 °F)	Float	Initial Charging Current Less than 8.75A Voltage 13.6-13.8V
	Cycle	Initial Charging Current Less than 8.75A Voltage 14.4-14.9V

Packaging

Battery Dimensions	Length	196mm
	Width	131mm
	Height	155mm
	Total Height	180mm
Box Dimensions	Length	211mm
	Width	144mm
	Height	211mm
Quantity Per Box		1 PCs per box
Net weight Per Cell		12 kg ±3%
Net weight Per Box		12kg
Gross Weight		12.5kg

Discharge Constant Current per Cell (Amperes at 77°F/25°C)

F.V/Time	5min	10min	15min	30min	45min	1h	2h	3h	5h	8h	10h	20h
1.60V	83.2	53.0	45.0	28.8	21.1	19.4	12.3	8.7	5.9	3.9	3.5	1.92
1.65V	81.6	52.1	44.2	28.2	20.8	19.1	12.1	8.5	5.8	3.8	3.4	1.89
1.70V	80.1	51.1	43.4	27.7	20.4	18.7	11.9	8.3	5.7	3.7	3.3	1.85
1.75V	78.6	50.1	42.6	27.2	20.0	18.3	11.7	8.2	5.6	3.7	3.3	1.82
1.80V	75.6	48.2	41.0	26.1	19.2	17.6	11.2	7.9	5.4	3.5	3.2	1.75

Discharge Constant Power per Cell (Watts at 77°F 25°C)

F.V/Time	5min	10min	15min	30min	45min	1h	2h	3h	5h	8h	10h	20h
1.60V	160.1	102.1	86.7	55.4	40.7	37.4	23.7	16.7	11.3	7.5	6.7	3.7
1.65V	157.2	100.2	85.1	54.4	39.9	36.7	23.3	16.4	11.1	7.3	6.5	3.6
1.70V	154.3	98.3	83.6	53.3	39.2	36.0	22.9	16.1	10.9	7.2	6.4	3.6
1.75V	151.4	96.5	82.0	52.3	38.5	35.3	22.5	15.8	10.7	7.1	6.3	3.5
1.80V	145.5	92.8	78.8	50.3	37.0	34.0	21.6	15.2	10.3	6.8	6.1	3.4

Note The above data are average values, and can be obtained within 3 charge/discharge cycles. These are not minimum values. Cell and battery designs/specifications are subject to modification without notice. Contact **US** for the latest information.

Performance Characteristics

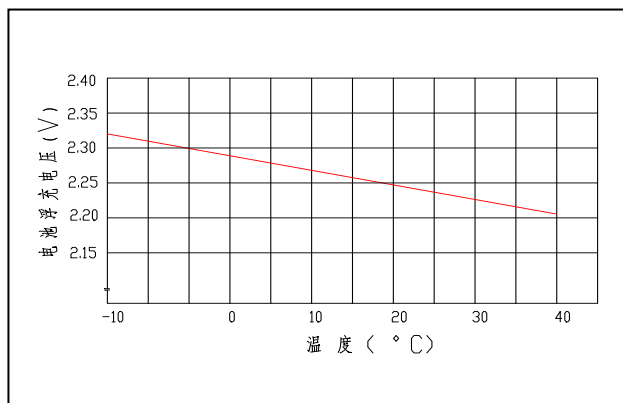
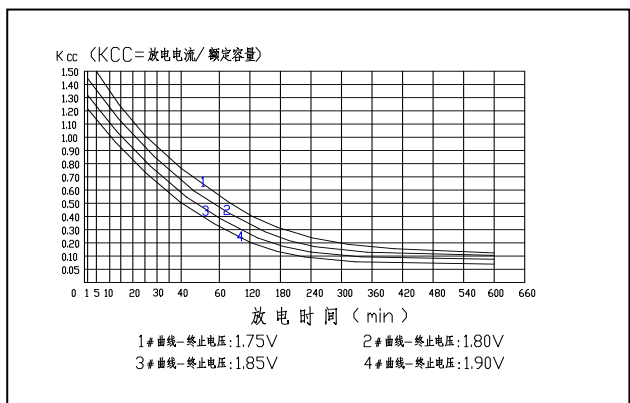
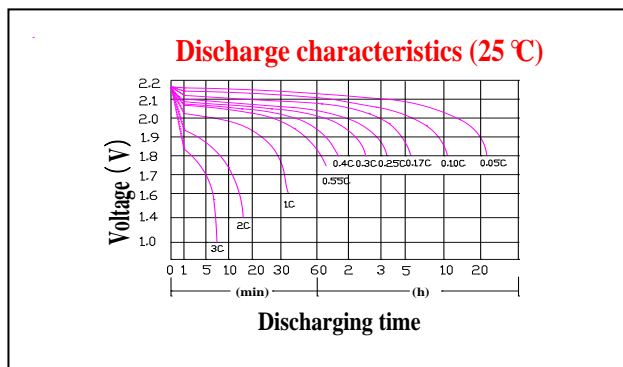
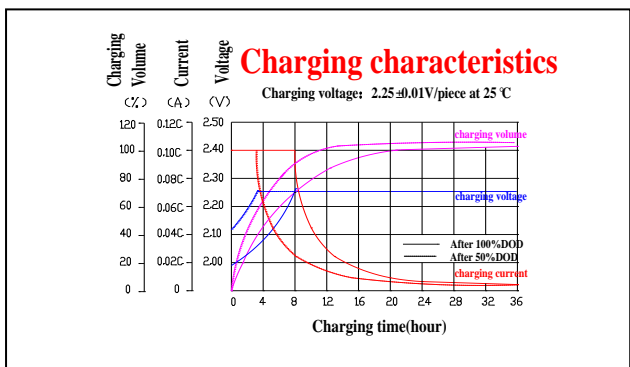
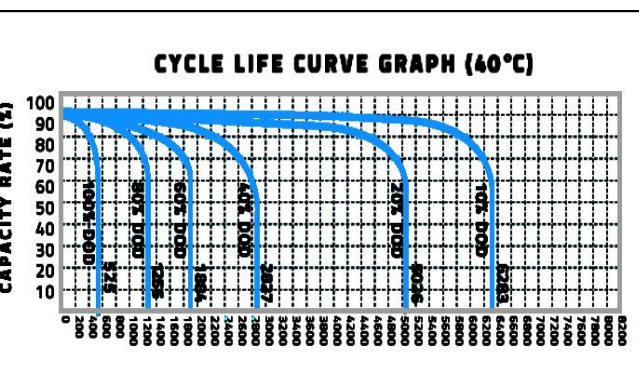
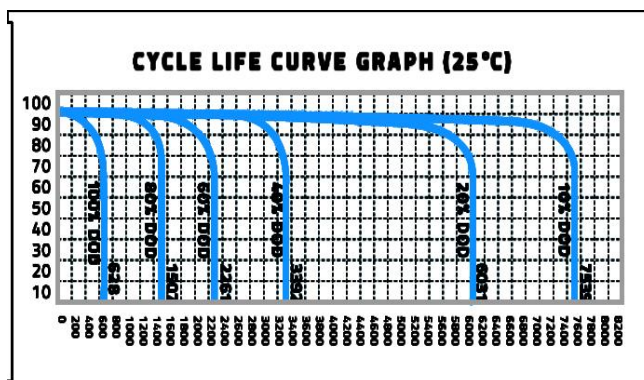
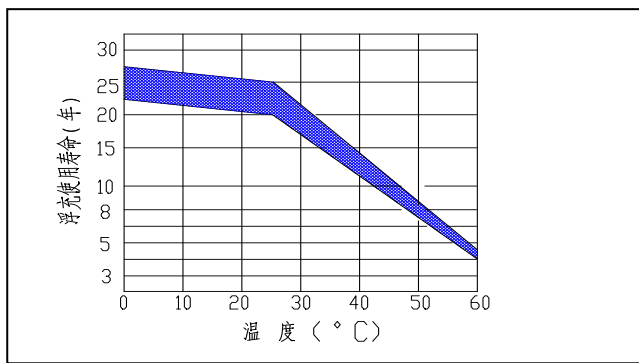
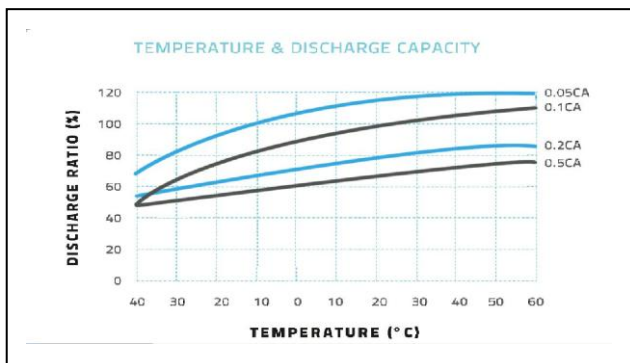

Battery Construction

Component	Positive plate	Negative plate	Container	Cover	Safety valve	Terminal	Separator	Electrolyte
Raw material	Lead dioxide	Lead	ABS	ABS	Si-Rubber	Copper	Fiberglass	Lead